



Parker IntraFlow™

ISA/ANSI SP76.00.02

Compliant Modular Systems

Catalog 4250
Revised, December 2003

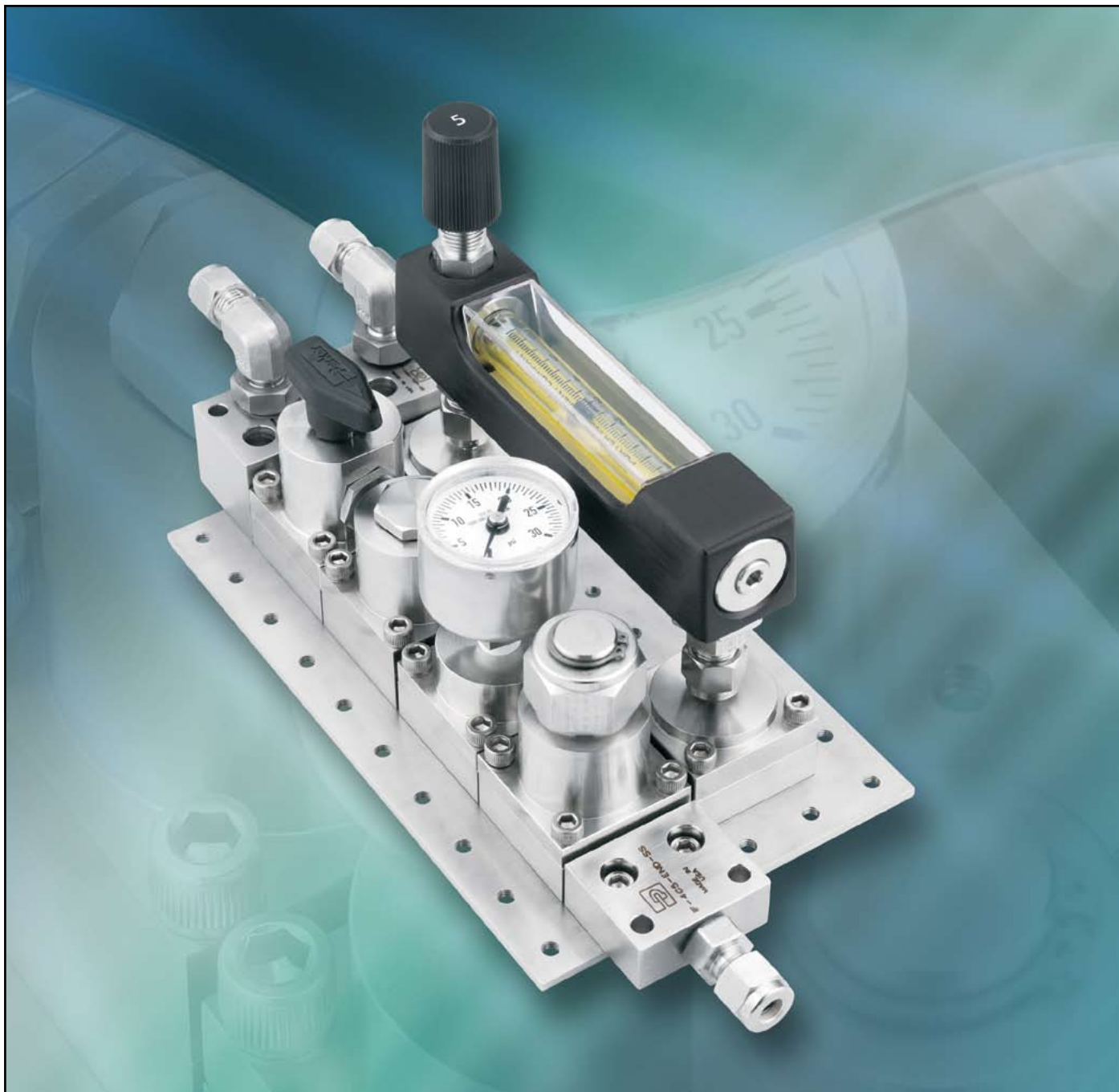

Parker IntraFlow™ Modular Systems

Introduction to Serious Simplicity

Parker IntraFlow™ substrate fittings have been developed specifically for analytical, lab and other complex general purpose instrumentation flow control systems. ISA/ANSI SP76.00.02 compliant, Parker IntraFlow™ fittings provide maximum flexibility with minimal space requirements. All flowpaths, regardless of direction, are maintained on a single plane within the system as there are no lower level manifold blocks required. Contiguous fitting flow paths are intra-connected with slip fit pressure connectors, while a threaded pegboard provides connection force and rigidity when fittings are mounted with cap screws. System assembly couldn't be simpler: a 5/32" hex head wrench is all you need to build with Parker IntraFlow™.

Design Features

- System size is reduced as much as 75% compared with conventionally plumbed systems, drastically reducing panel space, internal volume and purge times
- Compliant with ISA/ANSI SP76.00.02 open architecture standards
- Complex system assembly was never easier! No tube benders or cutters required, and no welding. All that's needed to assemble is a 5/32" hex head wrench!
- Every component on your Parker IntraFlow™ system can be reused when upgrading with emerging NeSSI Generation 2 & 3 technologies
- All flow paths are on the same plane: Parker IntraFlow™ eliminates lower level manifolds to minimize system weight and leak potentials
- Whether mounting a fitting to the standard 1/8" pegboard or a valve to the fitting, the same 10-32 x 1/2" SHCS is the only screw required

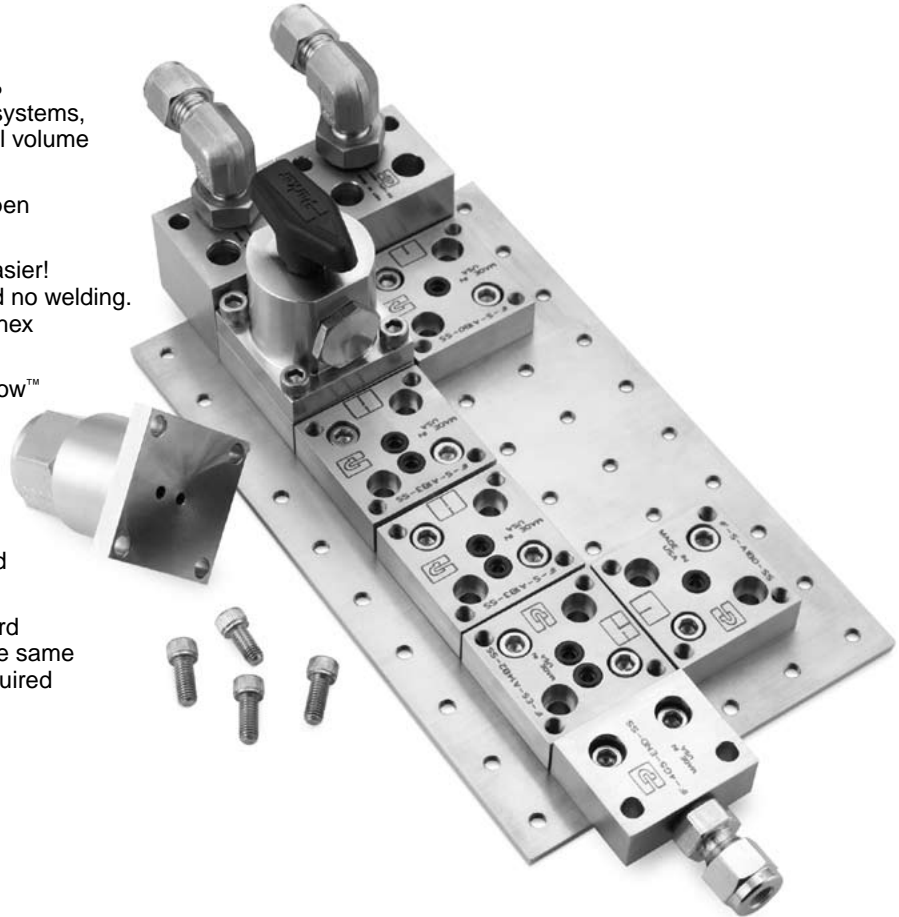

Specifications

- **Pressure Rating:**
Vacuum to 500 psig (34 bar) CWP
- **Temperature Ratings:**
 - Fluorocarbon Rubber
-15°F to 400°F (-26°C to 204°C)
 - Buna-N Rubber
-30°F to 275°F (-34°C to 135°C)
 - Ethylene Propylene Rubber
-70°F to 275°F (-57°C to 135°C)
 - Neoprene Rubber
-45°F to 250°F (-43°C to 121°C)
 - Highly Fluorinated Fluorocarbon Rubber
-25°F to 200°F (-32°C to 93°C)

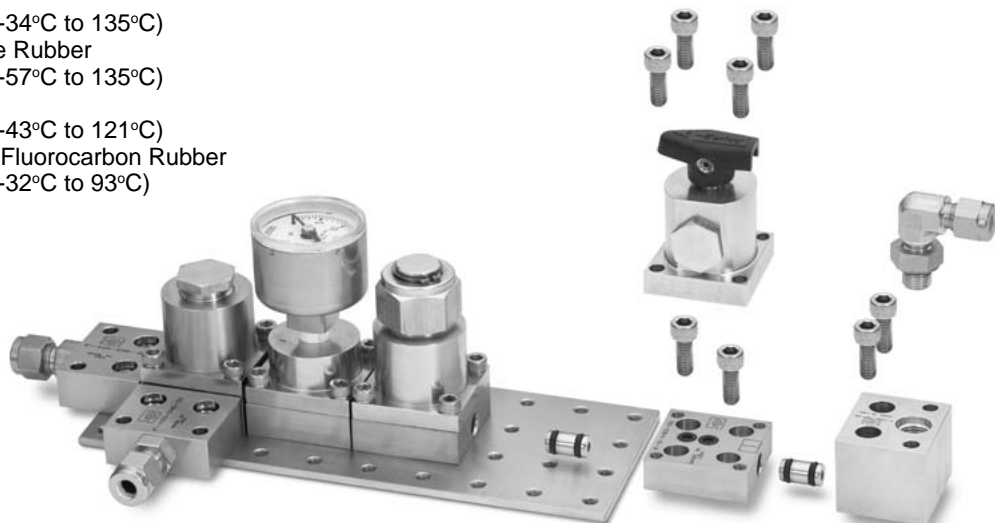

Patent Pending

Parker IntraFlow™ Heated Systems

Heated Systems

Conventionally fabricated heated systems typically utilize convection heaters inside an insulated enclosure. Parker IntraFlow™ systems deliver the heat through conduction directly where it's needed: within 5/32" of the actual fluid flowpath. Replacing the standard 1/8" thick pegboard with a 1/2" thick internally channeled plate, electric heat cartridges are easily inserted to heat fluid to desired temperatures. A steam heat ported pegboard is also available.

Design Features

- Heated pegboard is interchangeable with non-heated pegboard and easily converted
- Heat is applied through conduction directly to the base of the fitting, increasing heat efficiency
- Commercially available standard general purpose heater cartridges insert and connect directly into the pegboard via 1/8" FNPT connections
- Class I, Division 2 compliant cartridges are available with direct connect conduit connections
- Parker Multitube® heat traced tube bundles are available for sample delivery to IntraFlow™ systems. Multi-zone controllers are capable of integrating all control at one source
- Steam heat channeled pegboards are also available

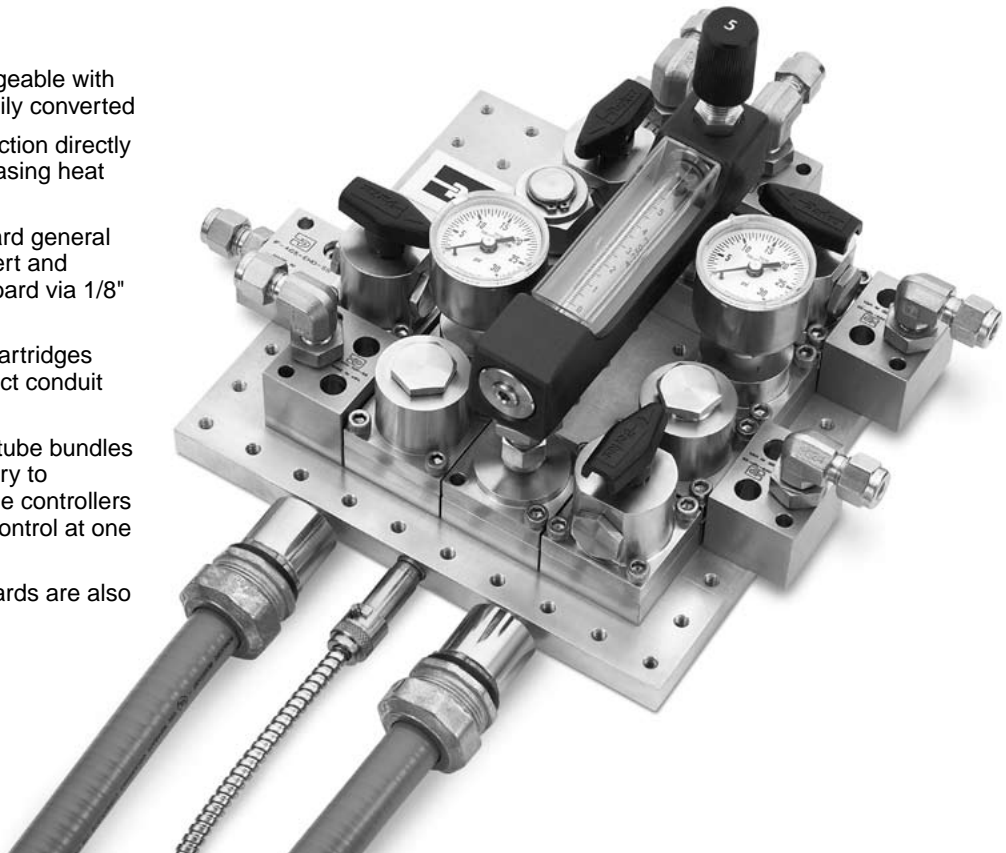

Electric Specifications

- 120 or 240 VAC, 50/60 Hz
- 40, 50, 75 watt cartridges
- General purpose 1/4" nominal cartridge with 1/8" FNPT threaded connection

Steam Specifications

- 1/8" FNPT supply and return connection ports
- 600 psig (41 bar) maximum steam pressure
- Maximum temperature capability determined by system o-ring selection

⚠ WARNING

FAILURE, IMPROPER SELECTION OR IMPROPER USE OF THE PRODUCTS AND/OR SYSTEMS DESCRIBED HEREIN OR RELATED ITEMS CAN CAUSE DEATH, PERSONAL INJURY AND PROPERTY DAMAGE.

This document and other information from Parker Hannifin Corporation, its subsidiaries and authorized distributors provide product and/or system options for further investigation by users having technical expertise. It is important that you analyze all aspects of your application and review the information concerning the product or system in the current product catalog. Due to the variety of operating conditions and applications for these products or systems, the user, through its own analysis and testing, is solely responsible for making the final selection of the products and systems and assuring that all performance, safety and warning requirements of the application are met.

The products described herein, including without limitation, product features, specifications, designs, availability and pricing, are subject to change by Parker Hannifin Corporation and its subsidiaries at any time without notice.

Offer of Sale

The items described in this document are hereby offered for sale by Parker Hannifin Corporation, its subsidiaries or its authorized distributors. This offer and its acceptance are governed by the provisions stated in the "Offer of Sale" located in Catalog 4110-U Needle Valves (U Series).

Parker IntraFlow™ Fittings



All Parker IntraFlow™ fittings are permanently marked with the part number, flow schematic and material heat traceability code for easy identification during assembly and when servicing in the field. 1/8" diameter internal flow paths are precision machined at the intersections to minimize dead volume. Slip fit counterbores with a lead-in chamfer retain intra-connecting pressure connectors.

Interface o-rings supplied separately [on page 6](#).

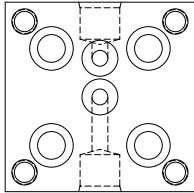

S-A1B3

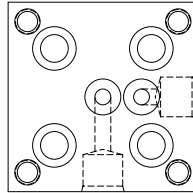

E-A1B4

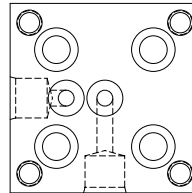

E-A1B2

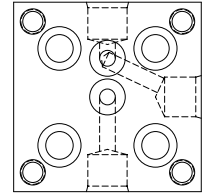

SE-A1B34

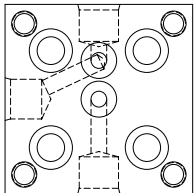

SE-A1B23

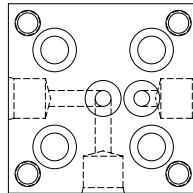

ES-A12B4

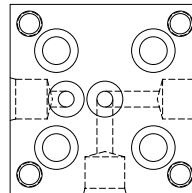

ES-A14B2

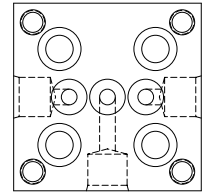

T-A1B24

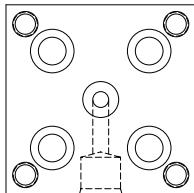

S-A1B0

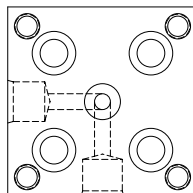

E-A12B0

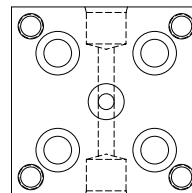

S-A13B0

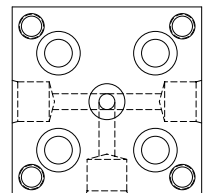

T-A134B0

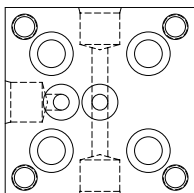

T-A13B2

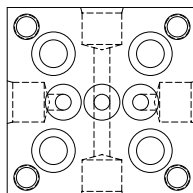

T-A13B24

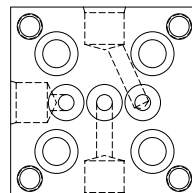

TR-A1B23

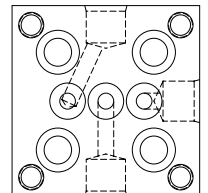

TL-A1B34

How To Order Parker IntraFlow™ Fittings

Example:

IF- T-A13B2- SS

Product	Generic and Defined Flowpath	Material
IF	From Chart	SS - 316 Stainless Steel

Field Connectors



End Access



Top Access

Connecting Parker IntraFlow™ systems to pressure sources is simply accomplished with a field connector. Both top and end access connections are available in 1/8" FNPT, 1/4" SAE and 1/4" Inverted CPI™ & A-LOK®.

How To Order Field Connectors

Example:

IF-	2F-	TOP-	SS
Product	Field Connection	Access	Material
IF	2F - 1/8" FNPT 4G5 - 1/4" SAE 4Z7 - 1/4" Inverted CPI™ 4A7 - 1/4" Inverted A-LOK®	TOP (access) END (access)	SS - 316 Stainless Steel

Pressure Connectors

Slip-fit Pressure Connectors provide flowpath intra-connectivity between Parker IntraFlow™ fittings. Pressure Connectors are fully assembled with AS568B standard size 2-008 o-rings and are available in both standard and jumper lengths (for systems with flow requirements between non-contiguous fittings). Orifice is 1/8" and various elastomers are available.



How To Order Pressure Connectors

Example:

IF-	CONNECTOR-	V-	SS	
Product	Component	Elastomer	Length	Material
IF	CONNECTOR	V - Fluorocarbon Rubber EPR - Ethylene Propylene Rubber BN - Buna-N Rubber NE - Neoprene Rubber KZ - Highly Fluorinated Fluorocarbon	Blank - Standard 1 - 1 Block Jumper	SS - 316 Stainless Steel

Mounting Screws



Parker IntraFlow™ requires only a single size screw to assemble an entire system. 10-32 UNF x 1/2" SHCS kits are available in bag quantities of 100. Material is 18-8 Stainless Steel.

Part number: 10-32x1/2-SHC-SCREW-100.

Interface O-Rings



AS568B standard 2-007 o-rings are placed in the counterbores of each Parker IntraFlow™ fitting, providing a seal with the mating surface mount component. Parker's inPHorm O-Ring Material Selection Software takes the guess work out of media compatibility with o-ring compounds. Elastomer compound recommendations are output from media descriptions (single & multiple components) and temperature inputs.

How To Order Interface O-Rings

Example:

IF-	ORING-	V-	250
Product	Component	Elastomer	Bag Quantity
IF	ORING	V - Fluorocarbon Rubber	50
		EPR - Ethylene Propylene Rubber	100
		BN - Buna-N Rubber	250
		NE - Neoprene Rubber	500
		KZ - Highly Fluorinated Fluorocarbon Rubber	10
			25
			50
			100

Pegboards & Brackets

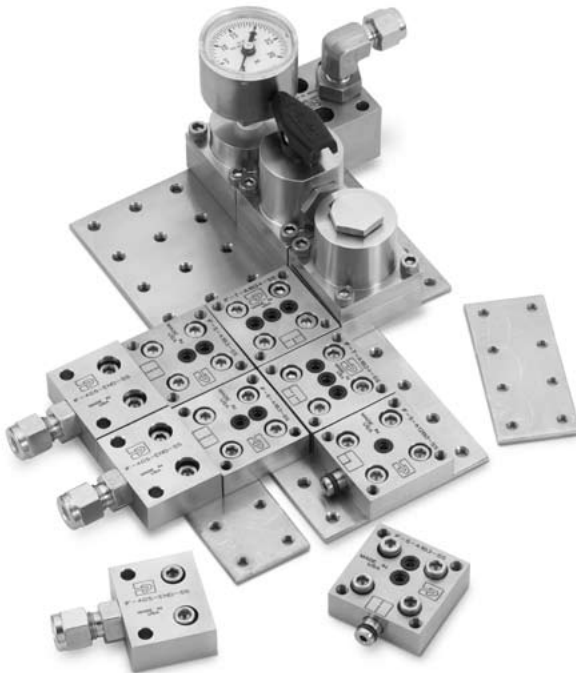

A wide range of heated and non-heated pegboard sizes are available to build your Parker IntraFlow™ system. Odd shaped or overside pegboards can be created by overlapping IntraFlow™ fittings across 2 standard pegboards. Heated pegboards are machined from ASTM 6061 aluminum while non-heated pegboards are machined from ASTM 304 stainless steel. Stainless steel brackets (minimum of 4 recommended) bolted at pegboard corner locations elevate the system for mounting to a backplane. Heated pegboards have holes bored in the end of the plate for either electric heater cartridges, thermocouples or steam. In all cases, 1/8" FNPT threads provide the connection port.

How To Order Pegboards

Example:

IF-	PEGBRD-	6x10-	ELEC
Product	Component	Size (hole matrix)	Style
IF	PEGBOARD	2x2	Blank - Non-Heated
		2x4	
		2x6	
		6x10	Blank - Non-Heated ELEC - Cartridge Heated STM - Steam Heated
		8x8	
		8x10	
		8x14	
		10x10	
		10x12	
		12x12	

Pegboard Mounting Bracket P/N's:

IF-MTGBRKT (non-heated pegboard)
IF-MTGBRKT-HEAT (heated pegboard)
(includes screws; 9/32" through hole for mounting to backplane).

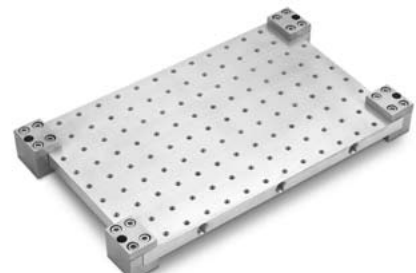

Adapters & Caps

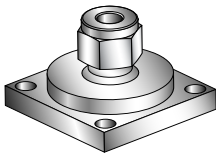

Compression Fitting

Surface mount adapters to common fitting connections are available for makeup to pressure indicators, thermocouples, sensors and other commercially available devices. Adapters are available in both 1 (-1P) or 2 (-2P) flow path configurations as shown in the drawings. Any of the -2P adapters may be plugged to provide a flow-through cap over an IntraFlow™ fitting planned for a future system function.

How To Order Adapters

Example:

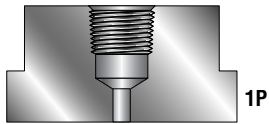

1 Port Adapter Connector

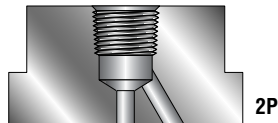

2 Port Adapter Connector

IF-	2F-	2P-	SS
Product	Connection	Ports	Material
IF	2A - 1/8" Inverted A-LOK® 2F - 1/8" FNPT 2Z - 1/8" Inverted CPI™ 4A - 1/4" Inverted A-LOK® 4F - 1/4" FNPT 4V - 1/4" Male VacuSeal 4V1 - 1/4" Female VacuSeal 4Z - 1/4" CPI™	1P - Single Port 2P - Double Port	SS - 316 Stainless Steel

Rotometer Adapters

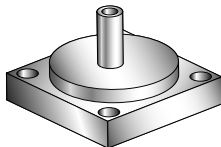

Offset Tube Stub

SP76.00.02 specifications require a 1.53" centerline spacing between all substrate fittings. Parker Rotometer adapters have 1/4" tube stubs machined 0.045" offset of the SP76.00.02 footprint to accommodate 4-1/2" rotometer port centerlines.

Part Number: IF-4TA-1P-OFFSET045-SS

Ball Valves

Product: B Series Ball Valve
Reference Catalog 4121-B

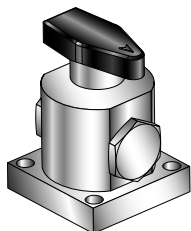

B2X Ball Valve

How To Order B Series Ball Valves

Example:

IF-	B2L	J-	V-	SS
Port	Series	Seat	Seal	Material
IF	B2L - 2 way B2X - 3 way	J - PTFE J2 - PCTFE	V - Fluorocarbon Rubber EPR - Ethylene Propylene BN - Buna-N Rubber	SS - 316 Stainless Steel

Standard handle is black mini-lever. Other handle options:

Colored Lever Handles: Add the designator corresponding to the correct handle as a suffix to the part number:
W — white, B — blue, G — green, R — red, Y — yellow **Example:** IF-B2LJ-V-SS-G

Colored Round Handles: Add the designator corresponding to the correct handle as a suffix to the part number:
S — black, S-W — white, S-B — blue, S-G — green, S-R — red, S-Y — yellow **Example:** IF-B2LJ-V-SS-S-G

3-Way Air Actuated Valves

Product: R-Max Air Actuated 3-way Valve
Reference Catalog 4140-R

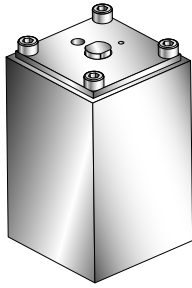

Regulator (45300792)

How To Order R-Max 3-Way Valves

Example:

IF-	R2S	K-	V-	SS
Port	Series	Seat	Seal	Material
IF	R2S	K - PCTFE	V - Fluorocarbon Rubber BN - Buna-N Rubber EPR - Ethylene Propylene Rubber NE - Neoprene Rubber KZ - Highly Fluorinated Fluorocarbon	SS - 316 Stainless Steel

Inline & Fast Loop Filters

Product: Inline Sintered Metal Filters
Reference Catalog 4130-FT

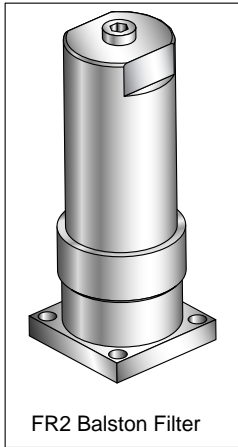

FR2 Balston Filter

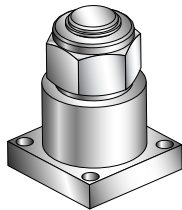

FT4 Filter

How To Order FT4 Inline Filters

Example:

IF-	FT4-	10-	V-	SS
Port	Series	Seal	Filter Type	Material
IF	FT4	1 - 1µm 5 - 5µm 10 - 10µm 50 - 50µm 100 - 100µm 250 - 250µm 450 - 450µm	V - Fluorocarbon Rubber BN - Buna-N Rubber EPR - Ethylene Propylene Rubber NE - Neoprene Rubber KZ - Highly Fluorinated Fluorocarbon	SS - 316 Stainless Steel

Product: Inline & Fast Bypass Filters
Reference Catalog IP-B

How To Order Inline & Bypass Filters

Example:

IF-	FR2-	V-	P	93-	SS	
Port	Series	Seal	Filter Type	Element Type		Material
				Balston P & C	Sintered Metal	
IF	FR2 - Inline FR3 - Bypass	V - Fluorocarbon Rubber BN - Buna-N Rubber EPR - Ethylene Propylene Rubber NE - Neoprene Rubber KZ - Highly Fluorinated Fluorocarbon	P - Particulate C - Coalescing S - Sintered 316SS	93 - 93% Microfibre 99 - 99% Microfibre	1 - 1µm 5 - 5µm 10 - 10µm 50 - 50µm 100 - 100µm 250 - 250µm 450 - 450µm	SS - 316 Stainless Steel

Check Valves

Product: CO Series Check Valve
Reference Catalog 4130-CO

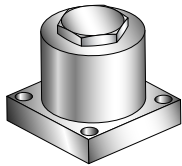

FT4 Filter

How To Order CO Series Check Valves

Example:

IF-	C04	5-	V-	SS
Port	Series	Crack Pressure	Seal	Material
IF	C04	1/3 psi 1 psi 5 psi 10 psi 25 psi 50 psi 75 psi 100 psi	V - Fluorocarbon Rubber BN - Buna-N Rubber EPR - Ethylene Propylene Rubber KZ - Highly Fluorinated Fluorocarbon	SS - 316 Stainless Steel

Needle Valves

Product: H Series Needle Valve
Reference Catalog 4190-HV

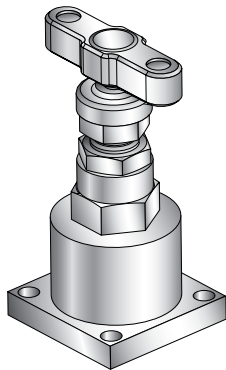

How To Order H Series Needle Valves

Example:

IF-	H4L	K-	V-	SS
Port	Series	Seat	Seal	Material
IF	H4	R - Blunt (30 deg) N - Needle (2-1/2 deg) K - PCTFE	Blank - PTFE BN - Buna-N Rubber EPR - Ethylene Propylene Rubber V - Fluorocarbon Rubber	SS - 316 Stainless Steel

Product: VQ Series Toggle Valve
Reference Catalog 4110-VQ

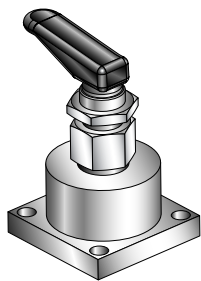

Toggle

How To Order VQ Series Toggle Valves

Example:

IF-	V4LQ	K-	V-	SS
Port	Series	Seat	Seal	Material
IF	V4LQ	Blank - PTFE K - PCTFE	Blank - PTFE BN - Buna-N Rubber EPR - Ethylene Propylene Rubber V - Fluorocarbon Rubber	SS - 316 Stainless Steel

Product: HR Series Metering Valve
Reference Catalog 4170-HR

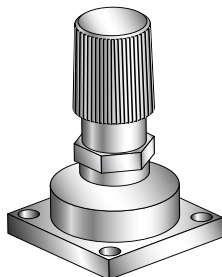

HR Metering Valve

How To Order HR Series Metering Valves

Example:

IF-	H3L	V-	SS-	NS	
Port	Series	Seal	Material	Handle Type	
IF-	H0L H1L H2L H3L H4L H5L H6L	(Max C.) .0004 .0070 .0140 .0200 .0300 .0470 .1180	V - Fluorocarbon Rubber BN - Buna-N Rubber EPR - Ethylene Propylene Rubber KZ - Highly Fluorinated Fluorocarbon	SS - 316 Stainless Steel	K - Knurled TC - Turns Counter NS - No Handle (slotted stem)

Relief Valves

Product: RL4 Relief Valve
Reference Catalog 4131-RL

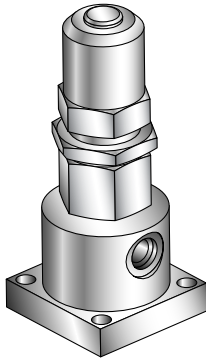

RL4 Relief Valve

How To Order RL Series Relief Valves

Example:

Port	Series	Seal	Backup Rings	Material	Actuation	Spring
IF-	RL4	V - Fluorocarbon Rubber BN - Buna-N Rubber EPR - Ethylene Propylene Rubber KZ - Highly Fluorinated Fluorocarbon NE - Neoprene Rubber	T - PTFE	SS - 316 Stainless Steel	Blank - Standard MN - Manual Override	KA - 10-25 psig KB - 25-50 psig KC - 50-100 psig KD - 100-150 psig KE - 150-225 psig KF - 10-225 psig KG - 225-400 psig

Quick Disconnects

Product: FS Series Non-Spill Coupler
Reference Catalog 4220-USA

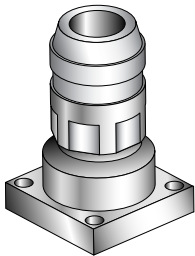

Female QC

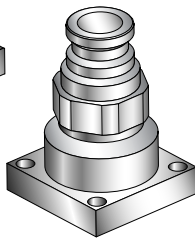

Male QC

How To Order FS Series Non-Spill Couplers

Example:

Port	Series	Seat	Seal	Material	Key/Color Code (Optional)
IF-	FS-	251 - Coupler 252 - Nipple	V - Fluorocarbon Rubber BN - Buna-N Rubber EPR - Ethylene Propylene Rubber KZ - Highly Fluorinated Fluorocarbon NE - Neoprene Rubber	SS - 316 Stainless Steel	(Blank) - Non-keyed/ color coded Brown - 1060 Black - 0045 Red - 2075 Orange - 3090 Yellow - 4105 Green - 5120

Pressure Reducing Regulators

Product: SMSQMICRO
Reference Catalog 25000143

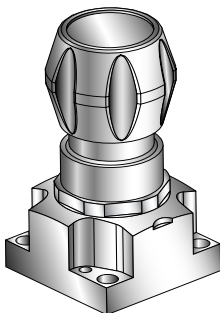

Regulator (45300792)

How To Order SMSQMICRO Regulators

Example:

Port	Outlet Pressure Range	Flowpath	Optional Features	Suffix
SMSQMICRO	30 - 0-30 psig 60 - 0-60 psig HF30 - 0-30 psig HF60 - 0-60 psig 130E30 - 0-30 psig 130E60 - 0-60 psig	10	(Blank): No Options SS: Stainless Steel Internals TH: Hastelloy C-22 Trim VESP: Vespel Seat	Ring

Diaphragm Valves

Product: SM930
Reference Catalog 25000146

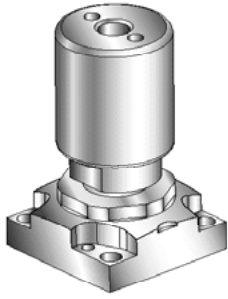

Diaphragm-actuated (54012129)

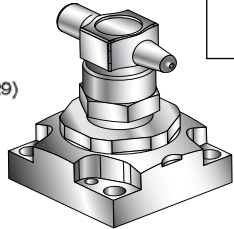

Diaphragm-Manual (45700205)

How To Order SM930 Series Diaphragm Valves

Example:

DM930-	LPNC	S	10	BK	RING
Port	Operator Type	Material	Flowpath	Optional Features	Suffix
SM930	G - Toggle M - Mini-Lever LPNC - Air Operated Normally Closed LPNO - Air Operated Normally Open	S - 316L Stainless Steel	10	LK - Lockout/Tagout (G Operator) LOTO: Lockout/ Tagout (M Operator)	Ring

Functional Systems

Basic Fast Loop System

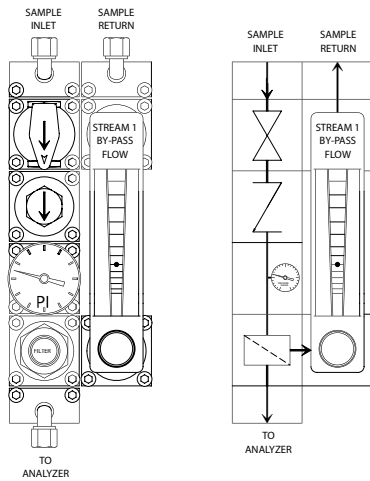

Parker IntraFlow™ systems are easily standardized to provide common functionality for analyzer sample systems. Standardized functions simplify field maintenance for technicians with "plug & play" system changeout. Parker design engineers have developed numerous standardized systems that are available factory built and tested. Custom designs are also available as kitted components, or factory assembled and tested units. Consult with your local Authorized Parker Instrumentation Distributor or contact the factory for more details.

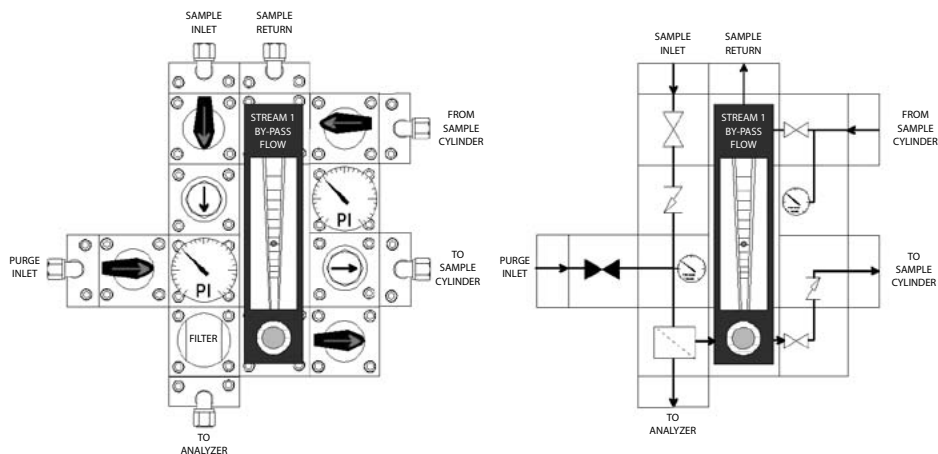

Enhanced Fast Loop System

